









**10020540 Josias**

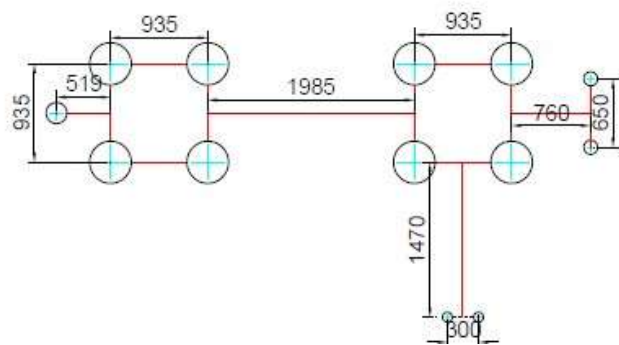
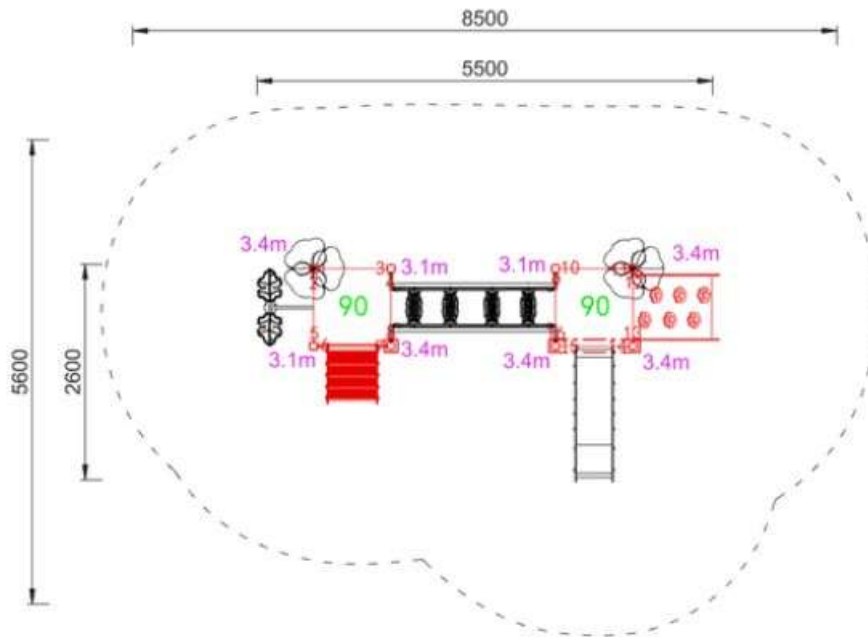

GW-05901 (2024)

			
Altersempfehlung (Jahre)	Age recommendation (years)	Recommandation d'âge (ans)	3 – 6
Maße Spielgerät (LxBxH cm)	Dimensions structure (LxWxH cm)	Dimensions de l'équipement (LxLxH cm)	550 x 260 x 330
Sicherheitszone (LxB cm)	Safety zone (LxW cm)	Zone de sécurité (LxL cm)	850 x 560
Freie Fallhöhe (cm)	Free fall height (cm)	Hauteur de chute libre (cm)	90
Podesthöhen (cm)	Platform heights (cm)	Hauteurs de plateforme (cm)	90
Anzahl Fundamente (St)	Number of foundations (pcs)	Nombre de fondations (pcs)	12
Fallschutz Empfehlung	Fall protection recommendation	Recommandation de revêtement amortissant	1 – 4
Aufbau: Zeit (ca. Std.)	Assembly: time (appr. h)	Montage: durée (env. h)	12
Funktionen	Functions	Fonctions	
Getestete Norm	Certificate	Norme testée	EN 1176
Garantie (Jahre)	Warranty (years)	Garantie (Jahre)	10
Längstes Teil (m)	Longest part (m)	Pièce la plus longue m)	3,4
Schwerstes Teil (kg)	Heaviest part (kg)	Pièce la plus lourde (kg)	100



								
Nr.	Bodenmaterial (DE)	Beschreibung (DE)	Ground material (EN)	Description (EN)	Matériau de sol (FR)	Description (FR)	Mindestschichtdicke / Minimum layers thickness / Épaisseur minimale	Größtmögliche freie Fallhöhe / Max. free fall height / Hauteur de chute libre maximale
1 (DE)	Beton/Stein	Pflaster	Concrete/stone	Paving	Béton/pierre	Pavés	-	≤ 600 mm
2 (DE)	Bitumen	Asphalt	Bitumen/asphalt	Asphalt	Bitume/asphalte	Asphalte	-	≤ 600 mm
3 (DE)	Oberboden	Mutterboden bis Dicke 20–30 cm	Topsoil	Topsoil up to 20–30 cm	Terre végétale	Terre végétale 20–30 cm	-	≤ 1000 mm
4	Rasen	gepflegte Rasenfläche	Grass	Maintained grass area	Gazon (entretenu)	Gazon entretenu	-	≤ 1000 mm (EUR) ≤ 1500 mm (DE)
5	Rindenmulch	Partikelgröße 20–80 mm	Bark mulch	Particle size 20–80 mm	Paillis d'écorce	Taille des particules 20–80 mm	200 mm 300 mm	≤ 2000 mm ≤ 3000 mm
6	Holzsplitter	Partikelgröße 5–30 mm	Wood chips	Particle size 5–30 mm	Copeaux de bois	Taille des particules 5–30 mm	200 mm 300 mm	≤ 2000 mm ≤ 3000 mm
7/8	Sand oder Kies	Korngröße 0,25–8 mm	Sand or gravel	Grain size 0,25–8 mm	Sable ou gravier	Taille des grains 0,25–8 mm	200 mm 300 mm	≤ 2000 mm ≤ 3000 mm
9	Synthetischer Fallschutz	wie nach EN 1177 geprüft	Synthetic safety surfacing	As tested according to EN 1177	Revêtement de sécurité synthétique	Comme testé selon EN 1177		nach Prüfung / as tested / comme testé

EN 1176-1:2017-12